



# CONECTOR FÊMEA RETO CRIMPAGEM RG e RGC-213

CÓDIGO: CF-36

SÉRIE: N 50 OHMS

NORMA: IEC 169-16

PESO DO CONECTOR: 25,12g

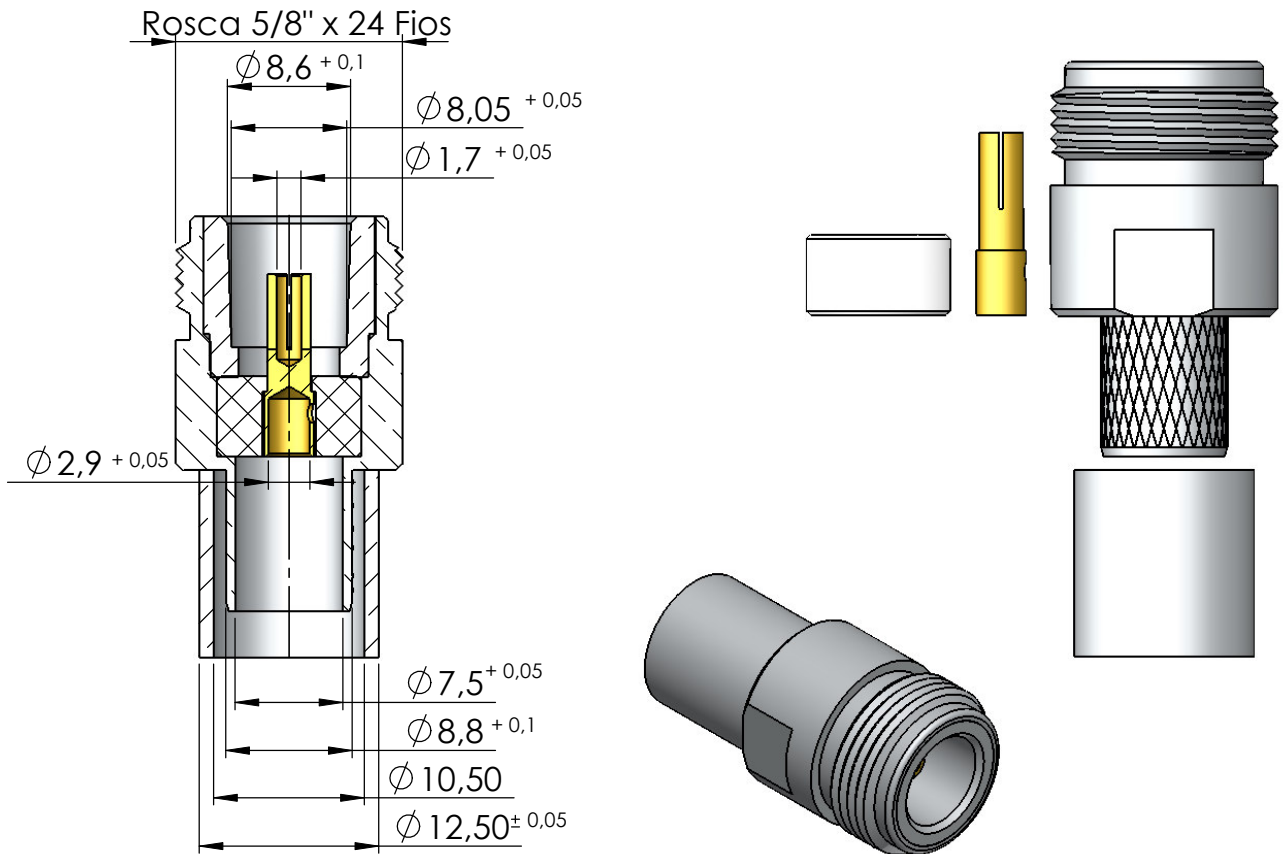

## Instruções montagem do cabo no conector

