



CONECTOR FÊMEA RETO CRIMPAGEM RG-58

CÓDIGO: CF-3ECR

SÉRIE: N 50 OHMS

NORMA: IEC 169-16

PESO DO CONECTOR: 28,73g

Rosca 5/8" x 24 Fios

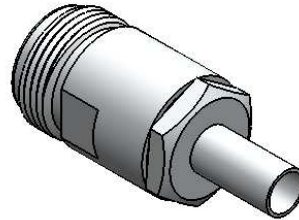
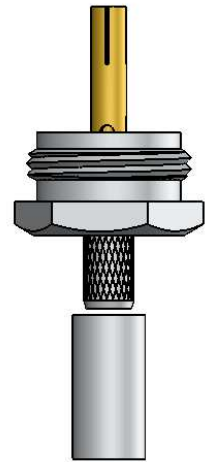
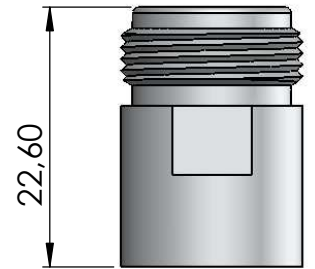
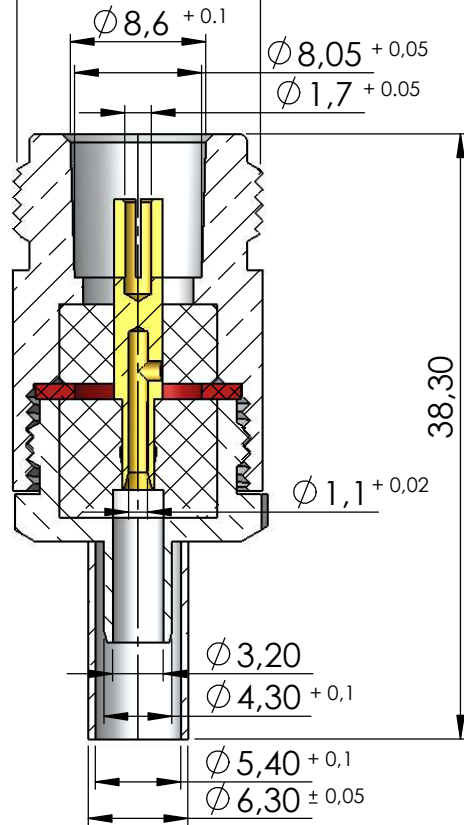

Instruções montagem do cabo no conector

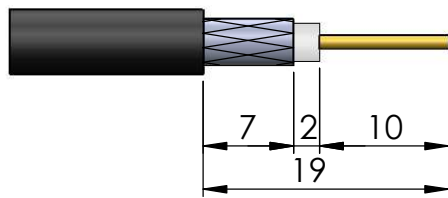

1) Corte do cabo.

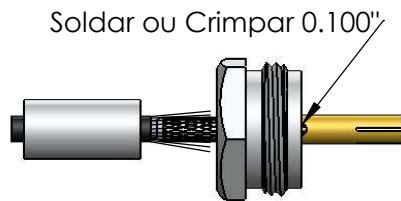

Soldar ou Crimpar 0.100"

3) Introduzir o condutor do cabo no pino, soldar ou crimpar. Colocando a malha sobre a parte recartilhada do redutor.

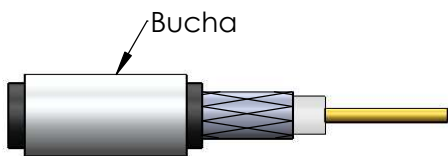

Bucha

2) Introduzir a bucha no cabo.

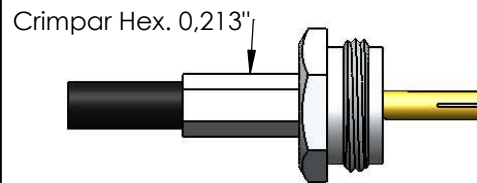

Crimpar Hex. 0,213"

4) Colocar a bucha sobre a malha até encostar no redutor e crimpá-la.

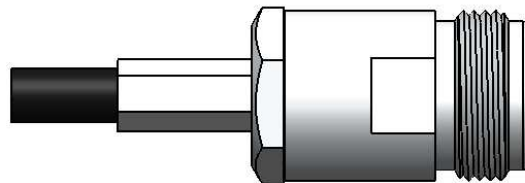

5) Introduzir o cabo no corpo do conector.