



CONECTOR MACHO RETO PRENSA CABO COAXIAL RÍGIDO 7/8"

CÓDIGO: KLP-4M

SÉRIE: UHF

NORMA: IEC 169-12

PESO DO CONECTOR: 362,66g

Rosca 5/8" x 24 Fios

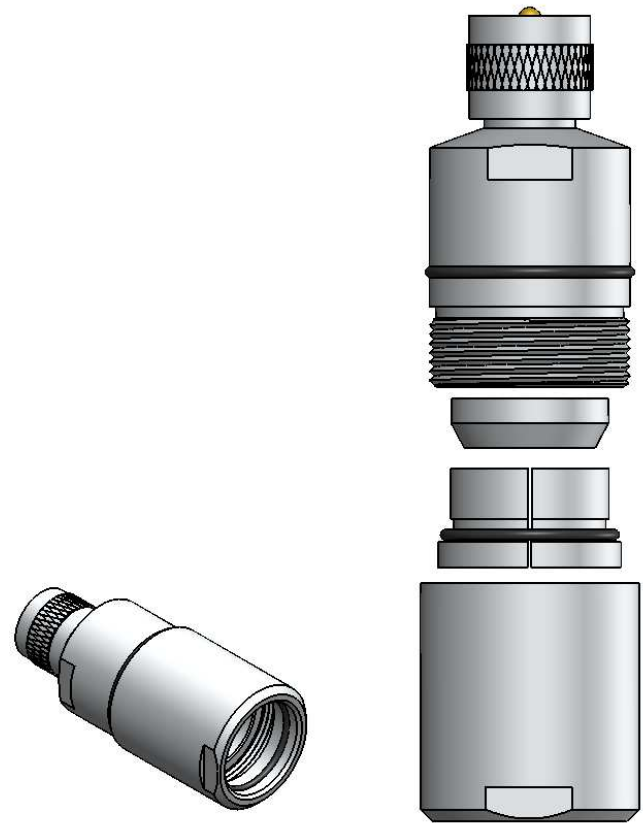
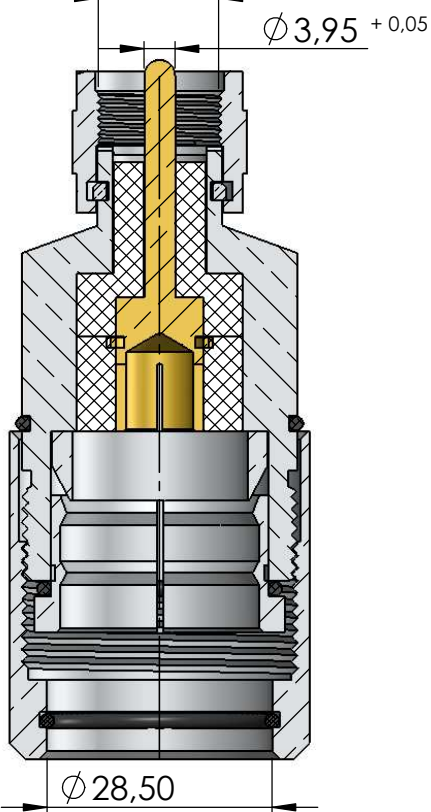

Instruções montagem do cabo no conector

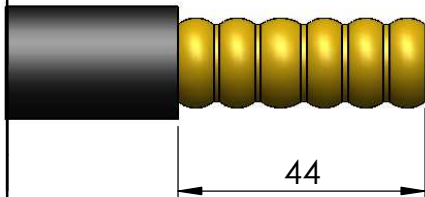

1) Corte do cabo.

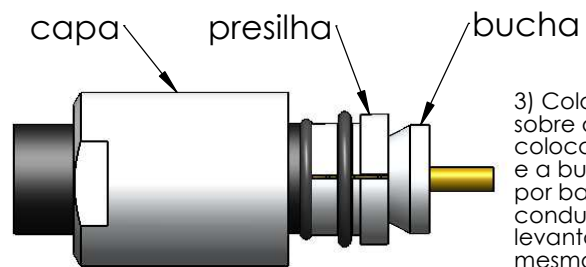

3) Colocar a capa sobre o cabo, colocar a presilha e a bucha cônica por baixo do condutor externo levantando o mesmo até encostar na presilha.

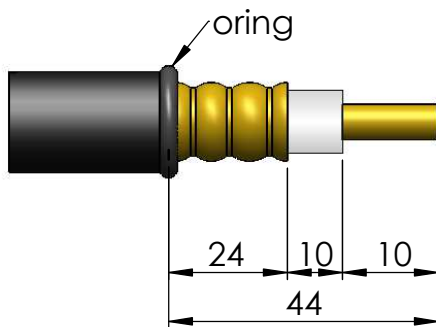

2) Cortar o cabo conforme figura e introduzir oring.

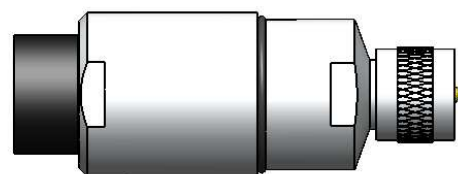

4) Introduzir o condutor central no contato do corpo, e rosquear a capa, e dar aperto final com chave.