



CONECTOR FÊMEA RETO PRENSA CABO RG-214

CÓDIGO: CF-57

SÉRIE: N 50 OHMS

NORMA: IEC 169-16

PESO DO CONECTOR: 53,61g

Rosca 5/8" x 24 Fios

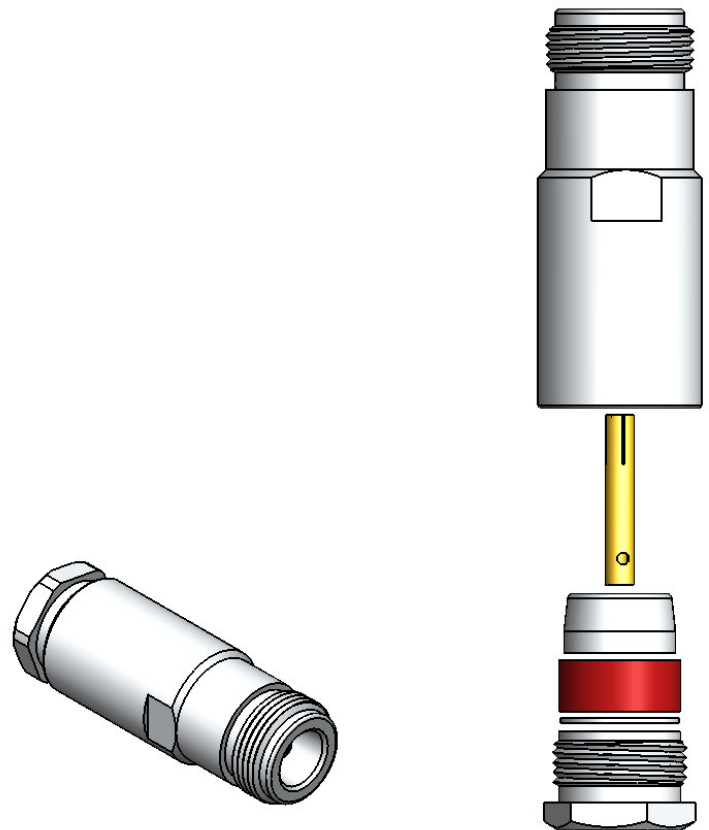
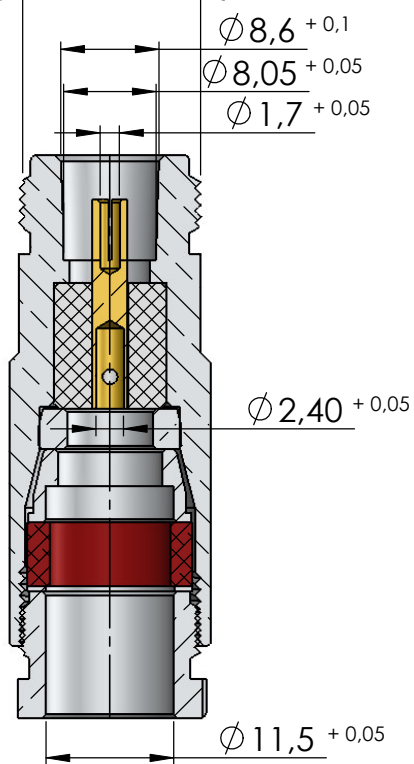

Instruções montagem do cabo no conector

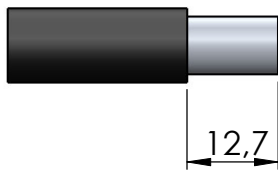

1) Cortar a capa de vinil expondo a malha 12,7mm.

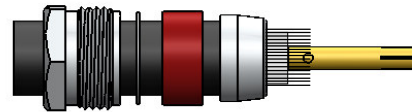

4) Fechar a malha e introduzir no cabo o redutor, arruela, anel de vedação e a bucha sobre a malha encostando na capa de vinil.



2) Abrir a malha e cortar o dielétrico expondo o condutor central 6,5mm.

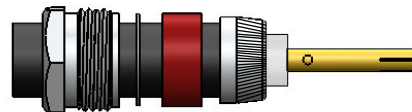

5) Dobrar a malha sobre a bucha e apará-la.

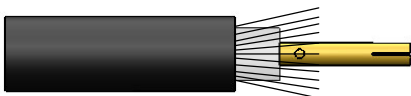

3) Soldar o condutor do cabo no pino.

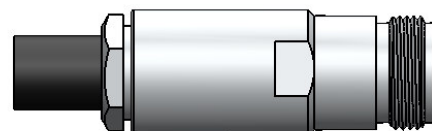

6) Introduzir o cabo com os componentes no conector e apertá-lo usando chaves apropriadas.