



CONECTOR MACHO RETO PRENSA CABO COAXIAL RÍGIDO 5/8"

CÓDIGO: CL-5M

SÉRIE: N 50 OHMS

NORMA: IEC 169-16

PESO DO CONECTOR: 253,01g

Rosca 5/8" x 24 Fios

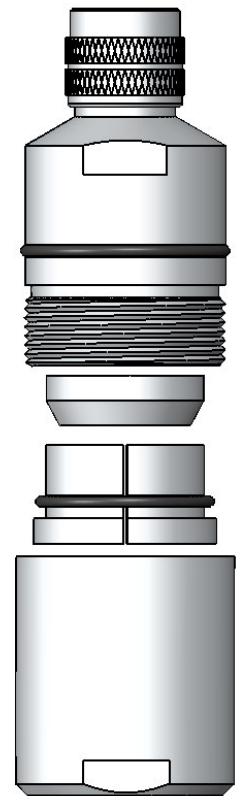
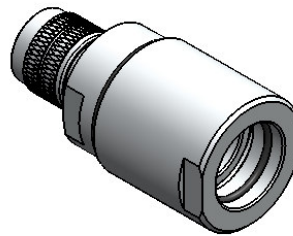
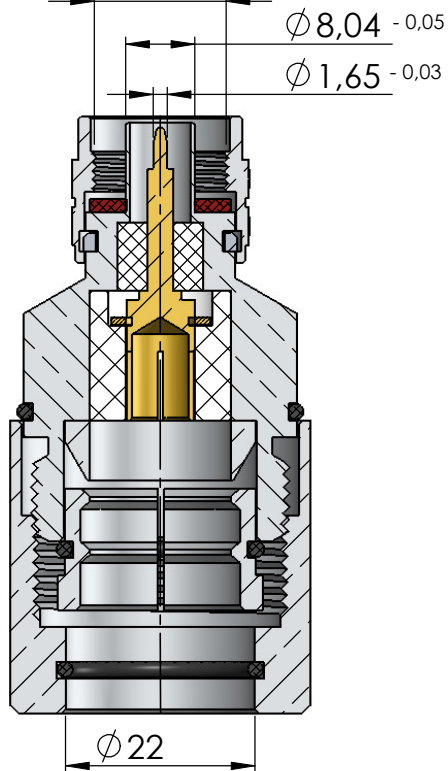

Instruções montagem do cabo no conector

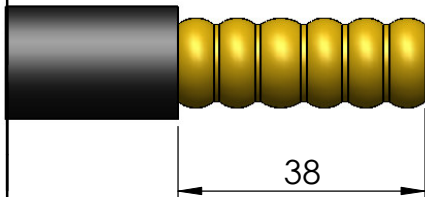

1) Corte do cabo.

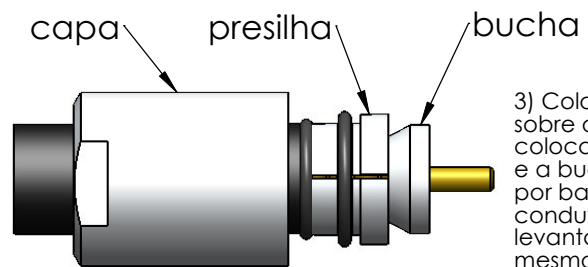

3) Colocar a capa sobre o cabo, colocar a presilha e a bucha cônica por baixo do condutor externo levantando o mesmo até encostar na presilha.

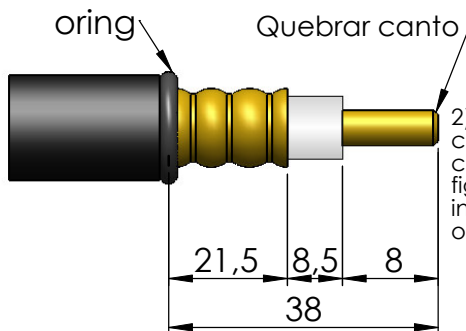

2) Cortar o cabo conforme figura e introduzir oring.

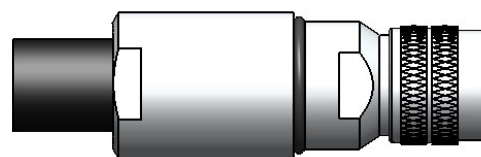

4) Introduzir o condutor central no contato do corpo, e rosquear a capa, e dar aperto final com chave.