



CONECTOR MACHO RETO PRENSA CABO WBC 240 e 240R, LMR- 240

CÓDIGO: CM-32

SÉRIE: N 50 OHMS

NORMA: IEC 169- 16

PESO DO CONECTOR: 28,03g

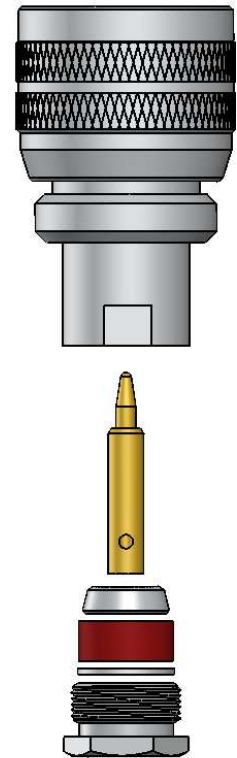
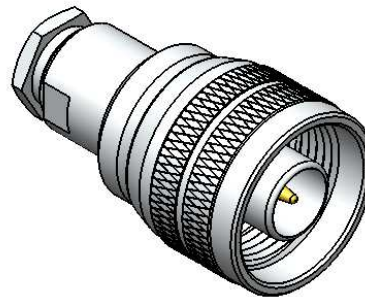
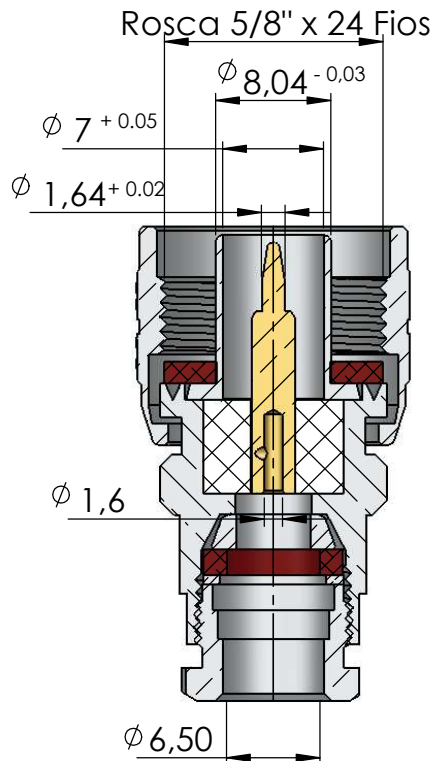

Instruções montagem do cabo no conector

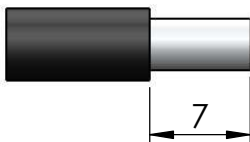

1) Corte do cabo.

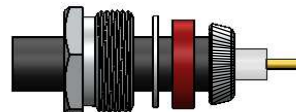

3) Dobrar a blindagem para traz e apará-la.

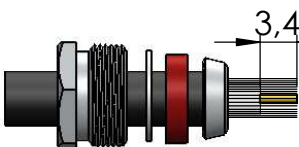

2) Desfiar a malha expondo 3,4mm do condutor central, fechar novamente a blindagem. Introduzir a porca, arruela, arruela neoprene e bucha cônica.

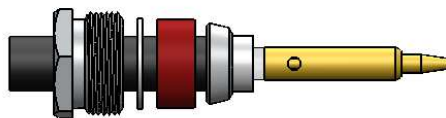

4) Introduzir o pino no condutor central, encostá-lo no dielétrico e soldar. Evitar excesso de calor para não deformar o dielétrico.

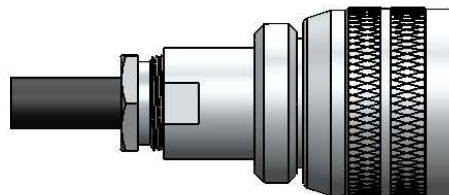

5) Introduzir o pino soldado no cabo no conector, e colocar o kit para fixação do cabo.