



# CONECTOR FÊMEA RETO PRENSA CABO RG/RGC - 58

CÓDIGO: 3044

SÉRIE: SMA 50 OHMS

NORMA: IEC 169-15

PESO DO CONECTOR: 3,58g

Rosca 1/4" x 36 Fios

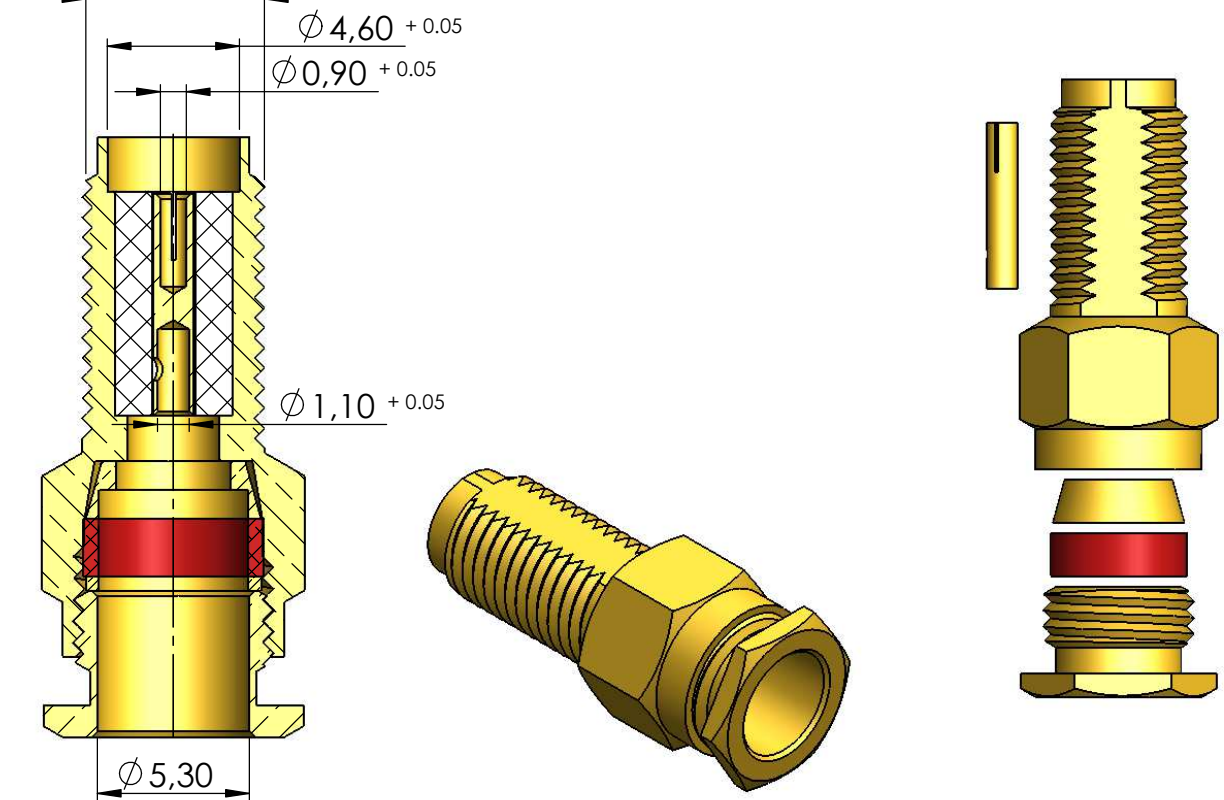

## Instruções montagem do cabo no conector

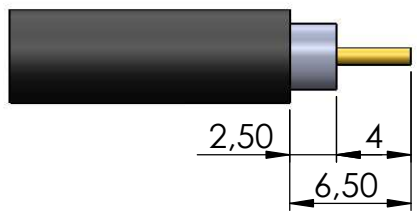

1) Corte do cabo.

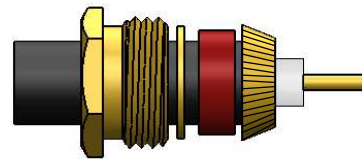

3) Dobrar a blindagem para traz e apará-la.

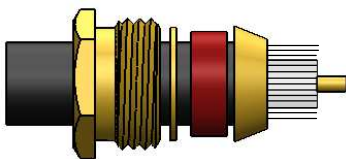

2) Introduzir a porca, arruela, arruela neoprene e bucha cônica.

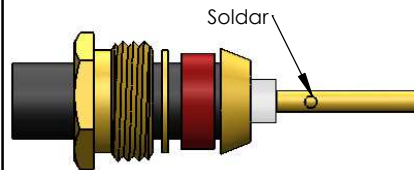

4) Introduzir o pino no condutor central, encostá-lo no dielétrico e soldar. Evitar excesso de calor para não deformar o dielétrico.

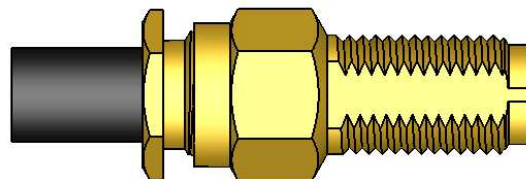

5) Introduzir o pino soldado no cabo no conector.