



CONECTOR FÊMEA RETO CRIMPAGEM RG/ RGC-58

CÓDIGO: KM- 2FCR

SÉRIE: UHF MINI

NORMA:

PESO DO CONECTOR: 10,18g

Rosca 3/8" x 24 Fios

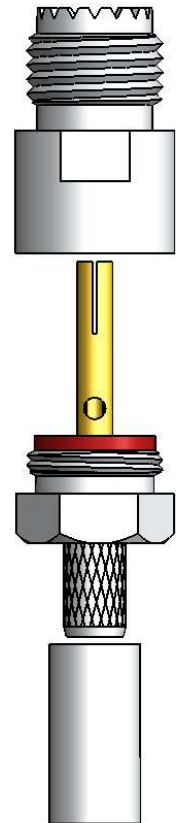
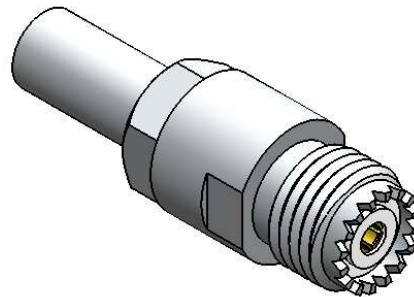
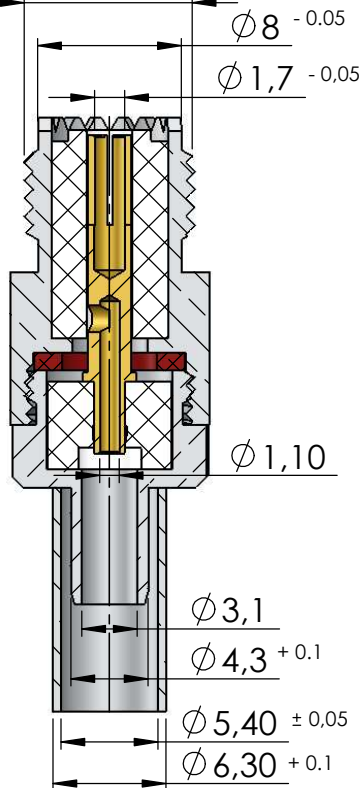

Instruções montagem do cabo no conector

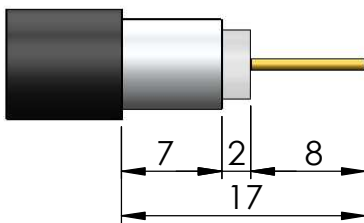

1) Corte do cabo.



3) Introduzir o condutor do cabo no pino, e crimpar ou soldar. Colocando a malha sobre a parte recartilhada do redutor.

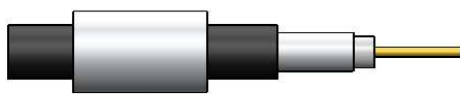

2) Introduzir a bucha no cabo.

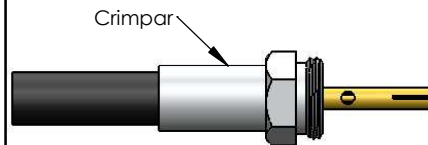

4) Colocar a bucha sobre a malha até encostar no redutor e crimpá-la.

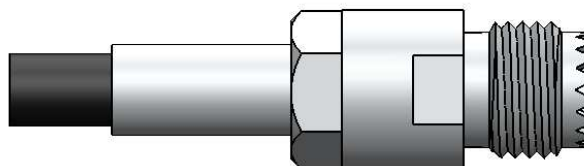

5) Introduzir o pino com o redutor no corpo de conector.