



CONECTOR MACHO ANGULAR CRIMPAGEM CABO RG-174

CÓDIGO: 10252

SÉRIE: DIVERSOS

NORMA:

PESO DO CONECTOR: 2,59g

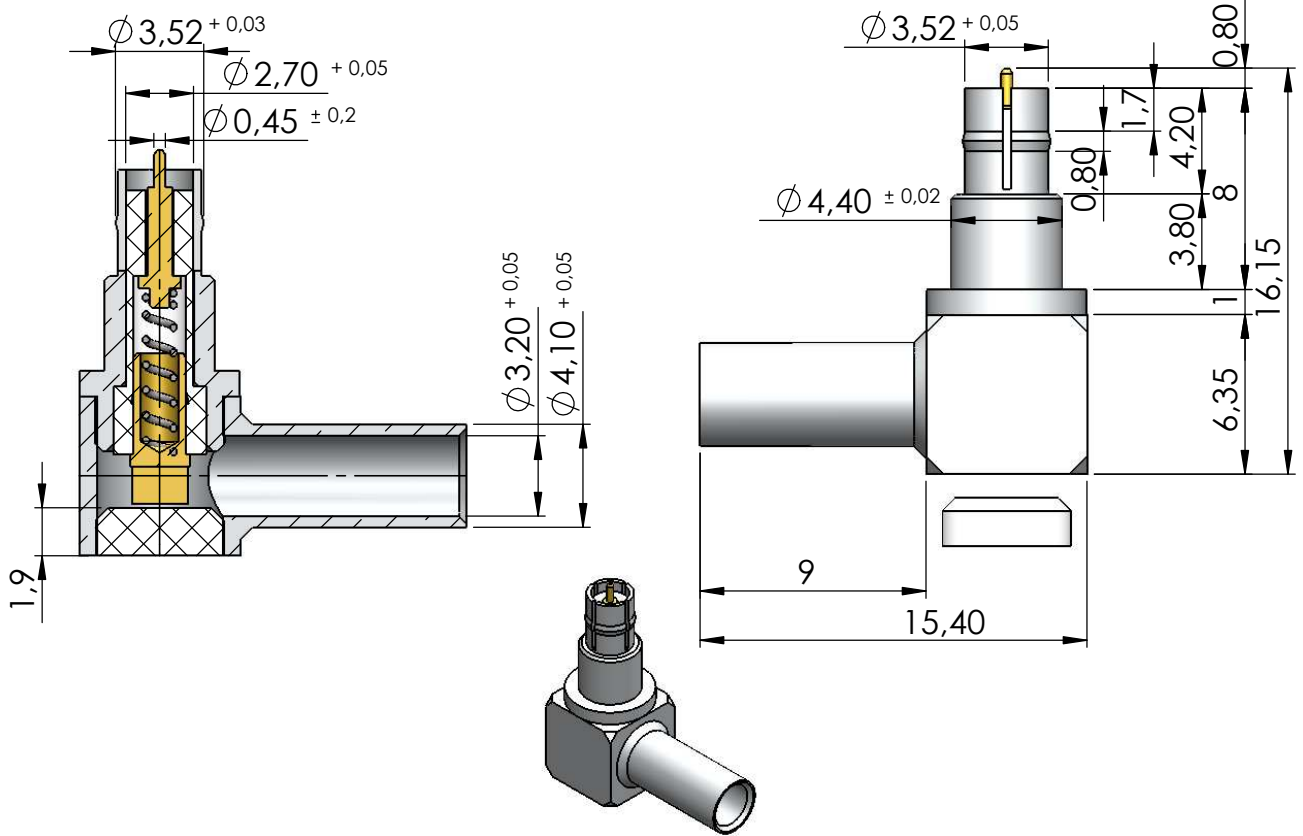

Instruções montagem do cabo no conector

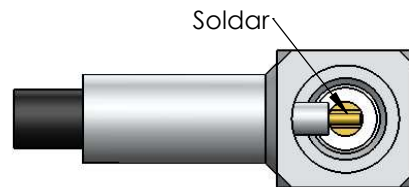
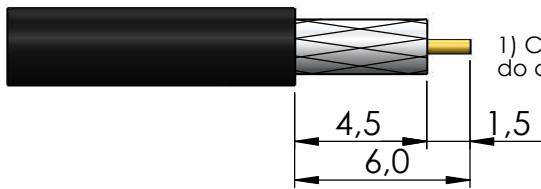

3) Introduzir o cabo com a malha dobrada no conector colocando o condutor do cabo na parte fresada do pino e soldar.

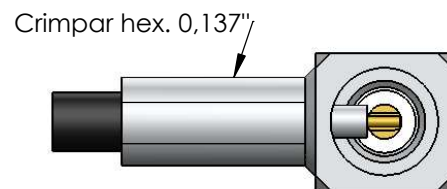
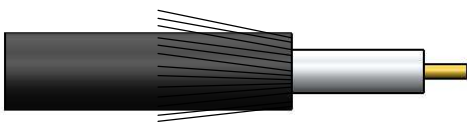

4) Crimpar o conector sobre o cabo.

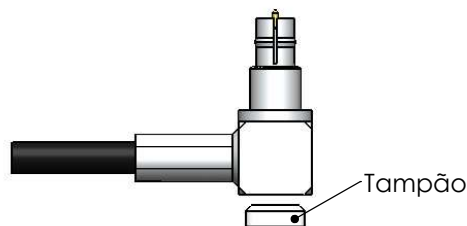

5) Prensar tampão na parte traseira.