



CONECTOR FÊMEA RETO PARA PAINEL CRIMPAGEM RF-75 0,4/2,6

CÓDIGO: LF-20

SÉRIE: BNC 50 OHMS

NORMA: IEC 169-8

PESO DO CONECTOR: 17,64g

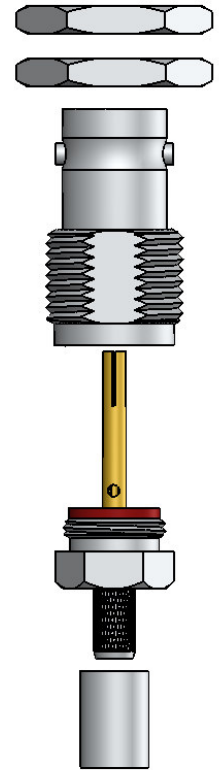
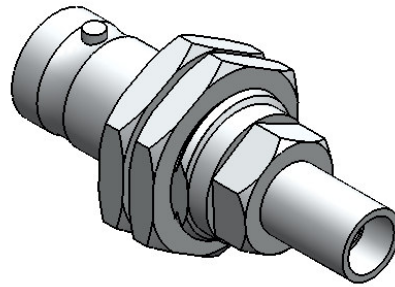
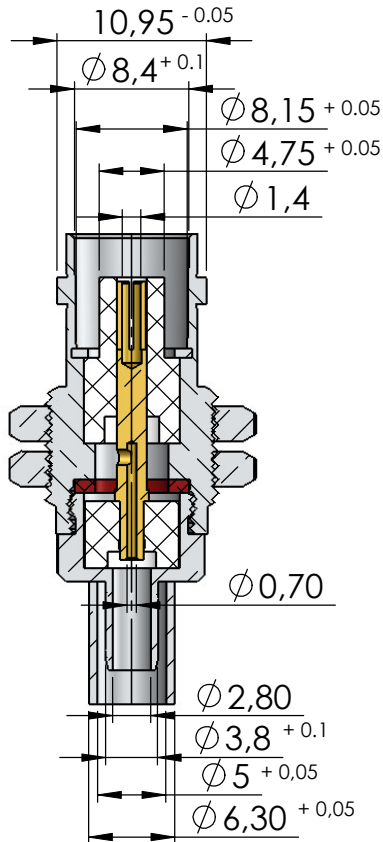

Instruções montagem do cabo no conector

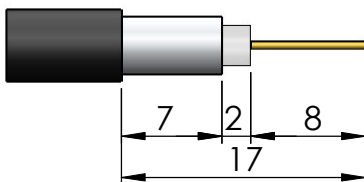

1) Corte do cabo.

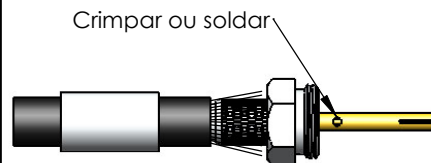

3) Introduzir o condutor do cabo no pino, e crimpar ou soldar. Colocando a malha sobre a parte recartilhada do redutor.



2) Introduzir a bucha no cabo.

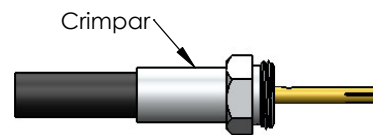

4) Colocar a bucha sobre a malha até encostar no redutor e crimpá-la.

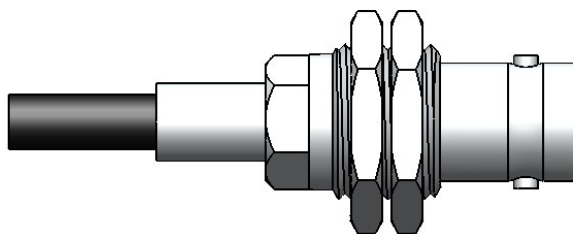

5) Introduzir o pino com o redutor no corpo de conector.