



CONECTOR MACHO RETO PINO FÊMEA CRIMPAGEM CABO LMR-240

CÓDIGO: 3183

SÉRIE: SMA 50 OHMS

NORMA: IEC 169-15

PESO DO CONECTOR: 5,06g

Rosca 1/4" x 36 Fios

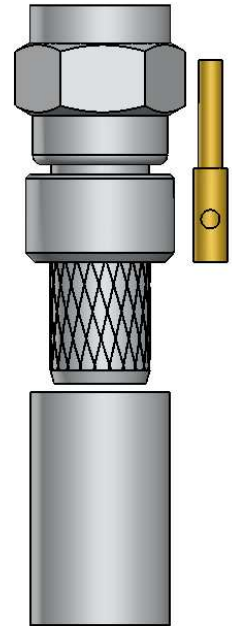
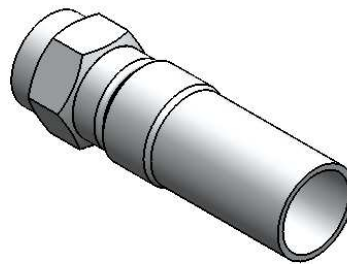
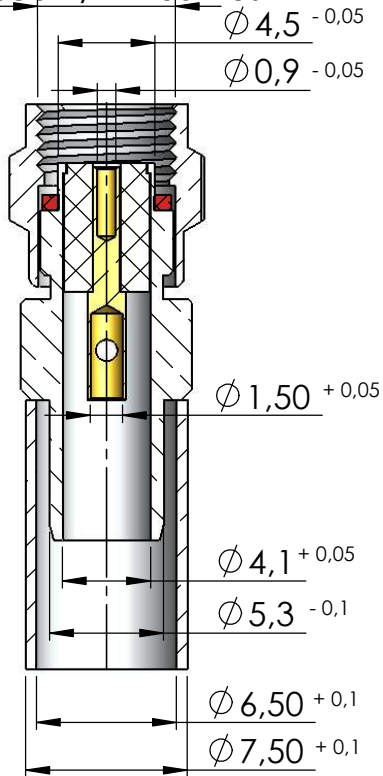

Instruções montagem do cabo no conector

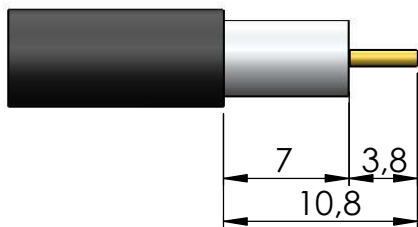

1) Corte do cabo.

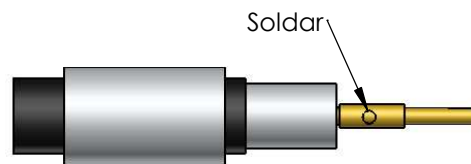

3) Soldar o condutor central no pino.

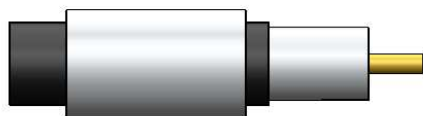

2) Introduzir a bucha no cabo.

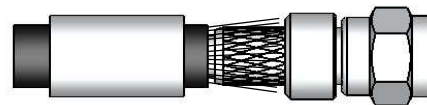

4) Introduzir o pino soldado no conector colocando a malha sobre a parte recartilhada do conector.

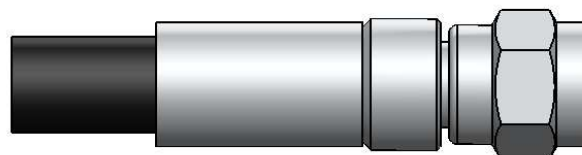

5) Colocar a bucha sobre a malha até encostar no conector e crimpá-la.