



# CONECTOR FÊMEA ANGULAR PRENSA CABO RG-58

CÓDIGO: 60058

SÉRIE: 1.6/5.6

NORMA: IEC 169-13

PESO DO CONECTOR: 11,39g

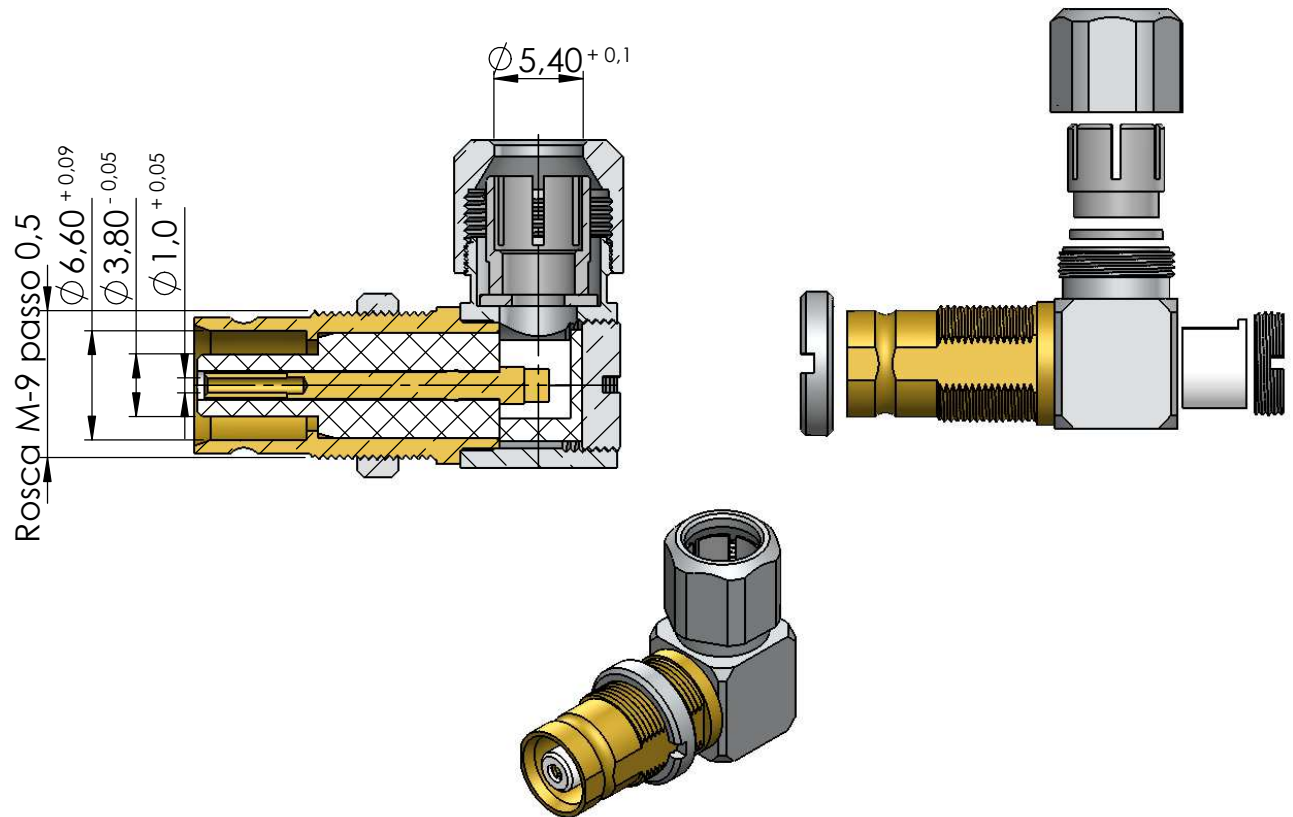

## Instruções montagem do cabo no conector

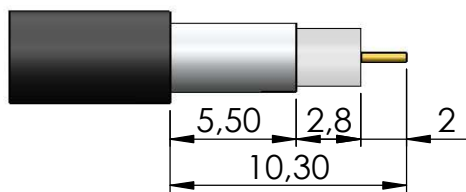

1) Corte do cabo.

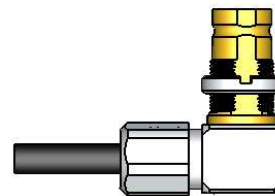

4) Introduzir o kit no conector e rosquear.

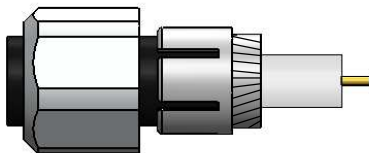

2) Introduzir o redutor no cabo, o atracador sobre a malha e dobrar a malha para traz.

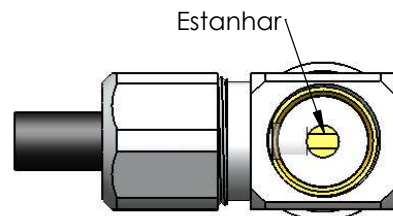

5) Estanhar o condutor do cabo no pino.

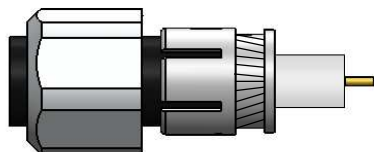

3) Colocar a bucha sobre o atracador e a malha.

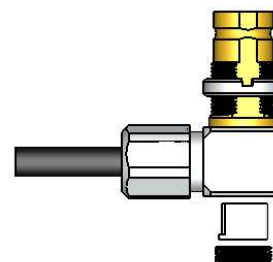

6) Colocar isolante e tampão no corpo.