



# CONECTOR MACHO ANGULAR PRENSA CABO RG-58

CÓDIGO: 90058

SÉRIE: 1.6/5.6

NORMA: IEC 169-13

PESO DO CONECTOR: 11,35g

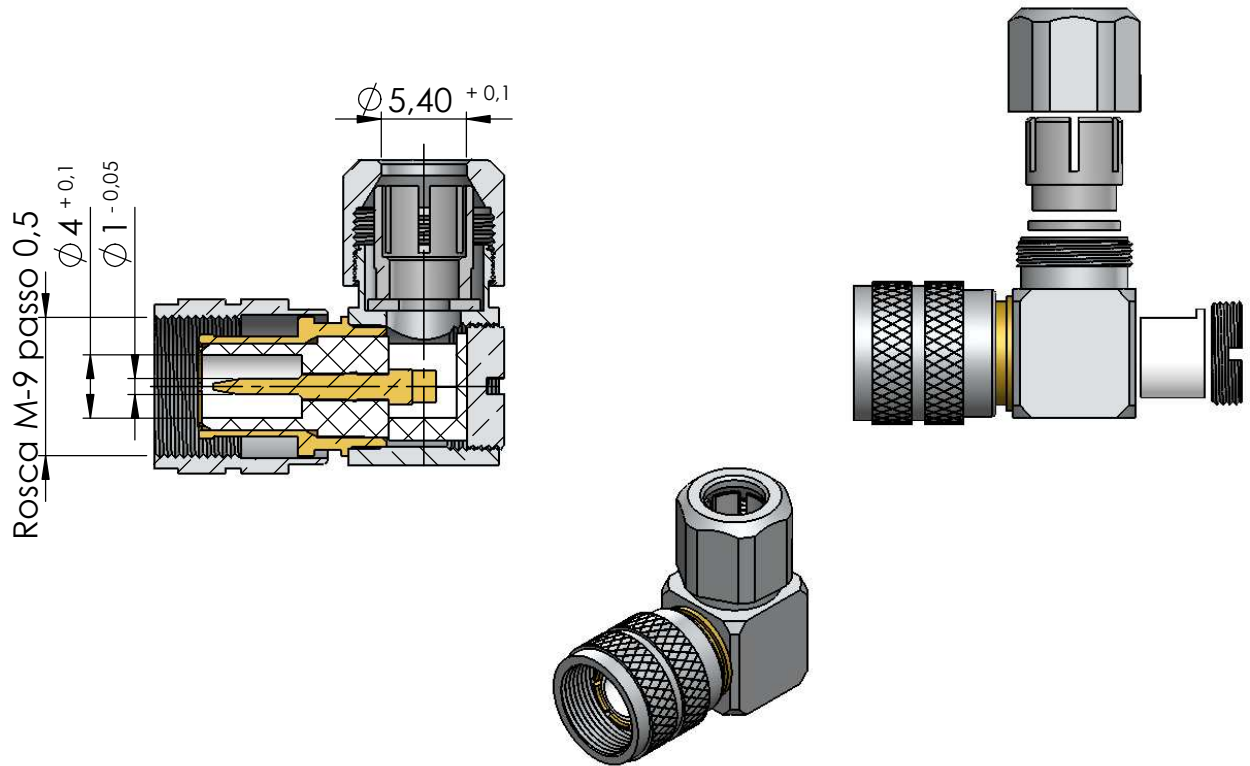

## Instruções montagem do cabo no conector

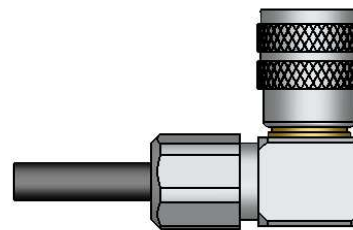
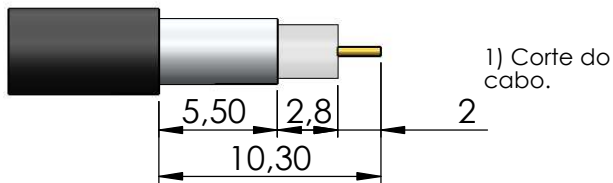

4) Introduzir o kit no conector e rosquear.

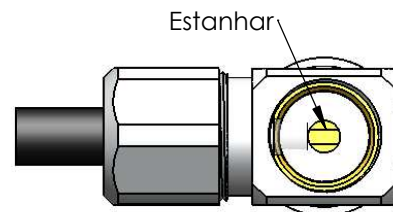
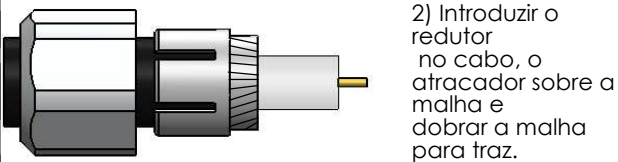

5) Estanhar o condutor do cabo no pino.

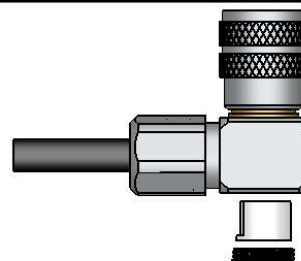
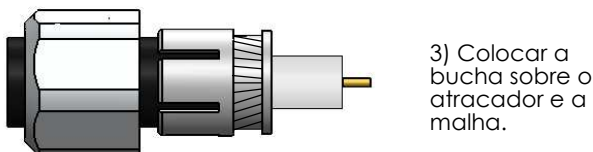

5) Colocar isolante e tampão no corpo.