



CONECTOR MACHO RETO CRIMPAGEM RG e RGC - 59

CÓDIGO: AC-25M

SÉRIE: ANTENA COLETIVA

NORMA: IEC 169-U

PESO DO CONECTOR: 19,59g

Rosca 3/8" x 32 Fios

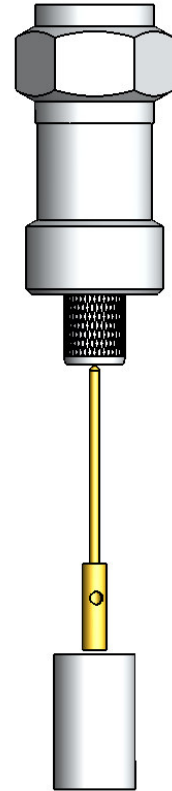
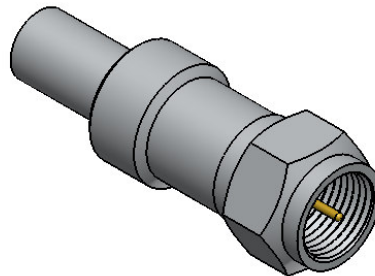
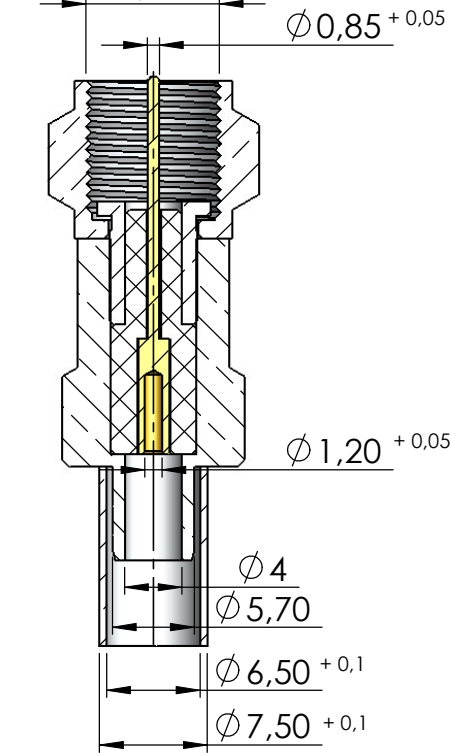

Instruções montagem do cabo no conector

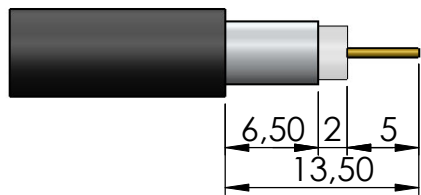

1) Corte do cabo.

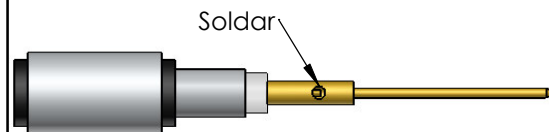

Soldar

3) Soldar o condutor central no pino.

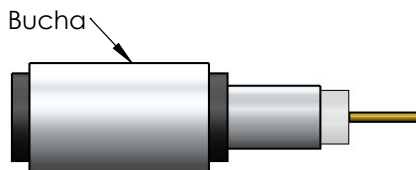

Bucha

2) Introduzir a bucha no cabo.

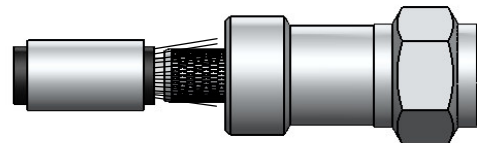

4) Introduzir o pino soldado no conector colocando a malha sobre a parte recartilhada do conector.

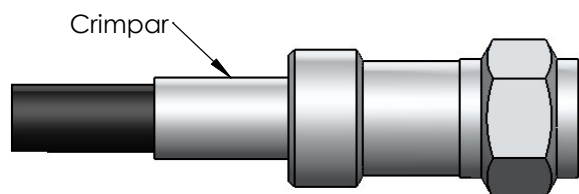

Crimpar

5) Colocar a bucha sobre a malha até encostar no conector e crimpá-la.