



CONECTOR MACHO ANGULAR CRIMPAGEM CABO RF-75 0,4/2,5

CÓDIGO: 3179

SÉRIE: SMA 50 OHMS

NORMA: IEC 169 - 15

PESO DO CONECTOR: 4,82g

Rosca 1/4" x 36 Fios

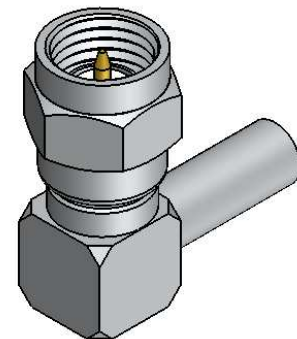
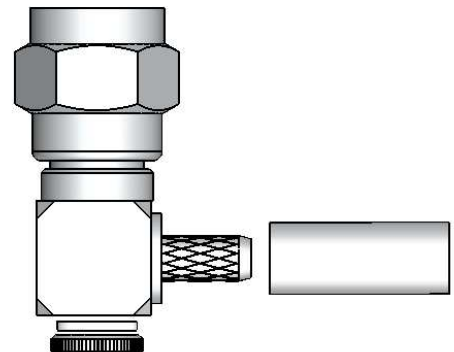
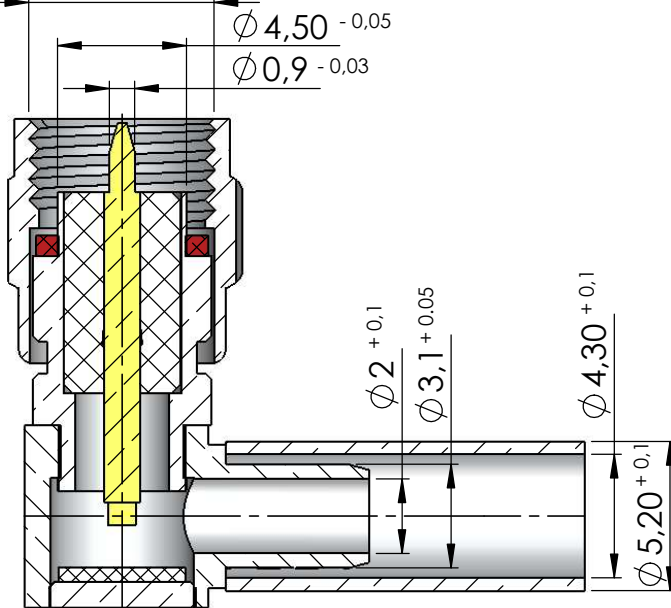

Instruções montagem do cabo no conector

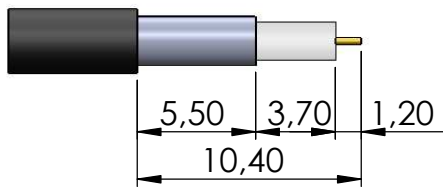

1) Corte do cabo.

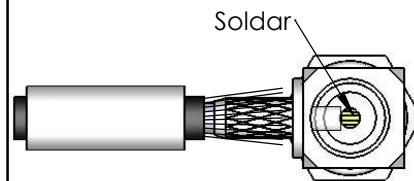

3) Introduzir o cabo no conector ate enconstar o condutor central no pino e soldar.

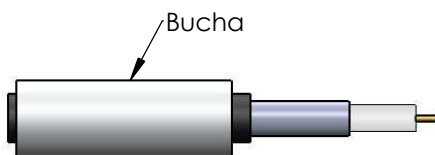

2) Introsduzir a bucha no cabo.

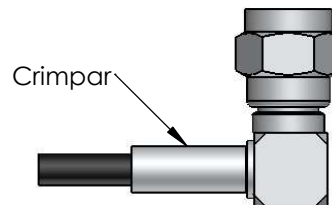

4)Introduzir a bucha no conector e crimpar.

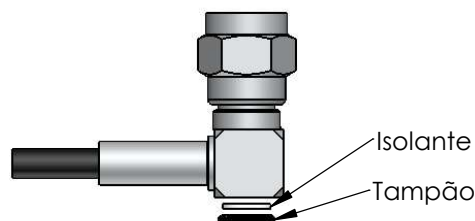

5) Colocar isolante e prensar tampão.