



# CONECTOR MACHO RETO CRIMPAGEM CABO RG-174

CÓDIGO: 4117

SÉRIE: SMB 50 OHMS

NORMA: IEC- 169 10

PESO DO CONECTOR: 3,74g

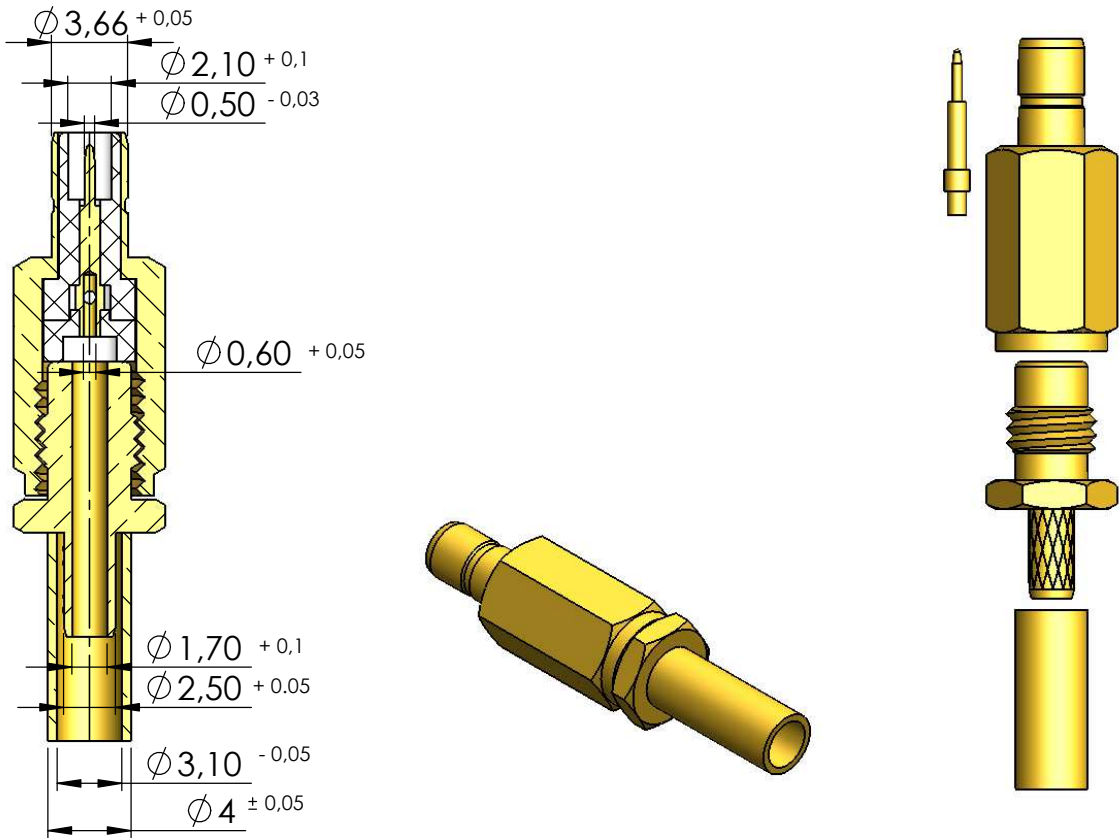

## Instruções montagem do cabo no conector

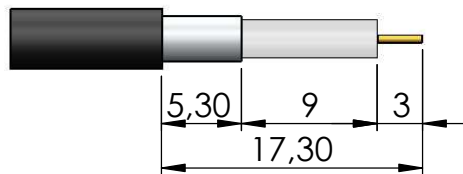

1) Corte do cabo.

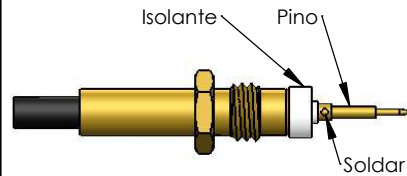

4) Introduzir o pino com o isolante até encostar o dielétrico no isolante, e soldar.

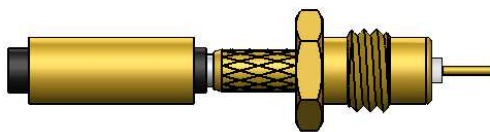

2) Introduzir a bucha e o redutor no cabo.

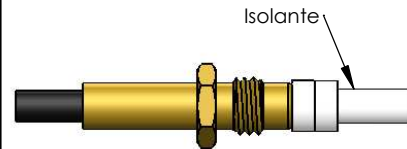

5) Introduzir o isolante sobre o pino.

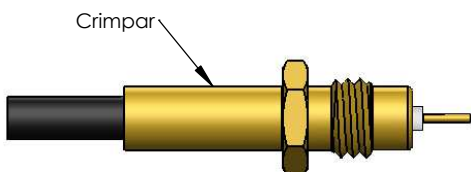

3) Crimpar a bucha no redutor.

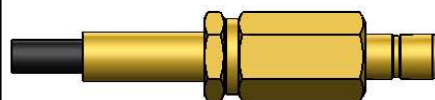

6) Introduzir o redutor no corpo e rosquear.