



CONECTOR FÊMEA ANGULAR P/ PAINEL PRENSA CABO RF-75 0,25/1,2

CÓDIGO: 60512

SÉRIE: 1.6/5.6

NORMA: IEC 169-13

PESO DO CONECTOR: 13,22g

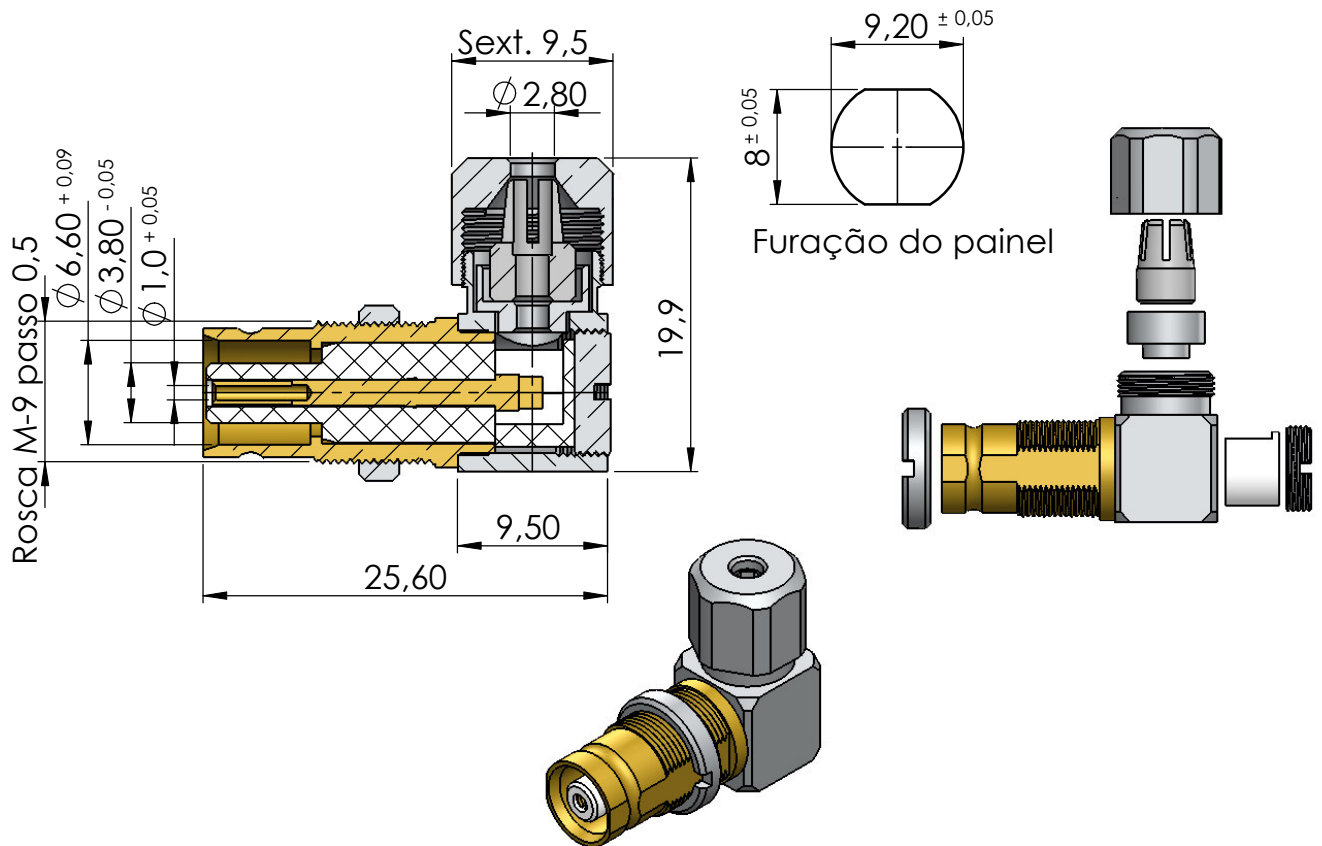

Instruções montagem do cabo no conector

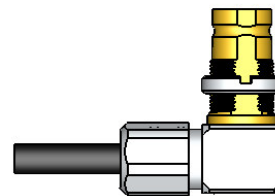
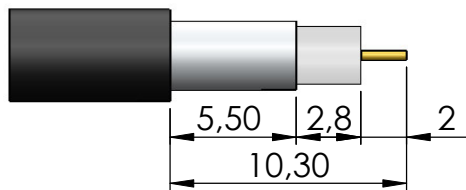

4) Introduzir o kit no conector e rosquear.

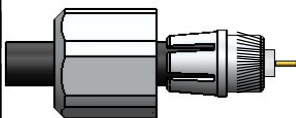

2) Introduzir o redutor no cabo, o atracador sobre a malha e dobrar a malha para traz.

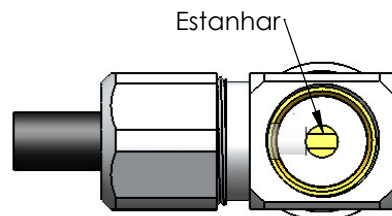

5) Estanhar o condutor do cabo no pino.

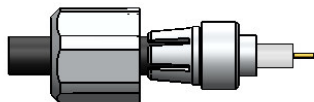

3) Colocar a bucha sobre o atracador e a malha.

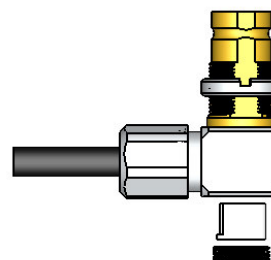

6) Colocar isolante e tampão no corpo.