



# CONECTOR MACHO RETO PRENSA CABO RG e RGC-213

CÓDIGO: CM-51

SÉRIE: N 50 OHMS

NORMA: IEC 169-16

PESO DO CONECTOR: 49,78g

Rosca 5/8" x 24 Fios

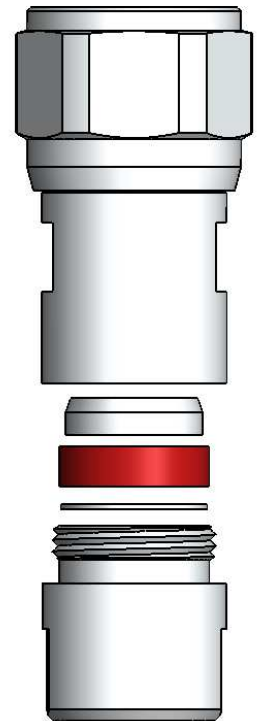
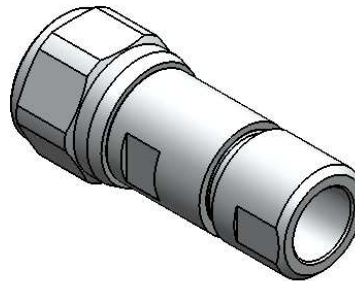
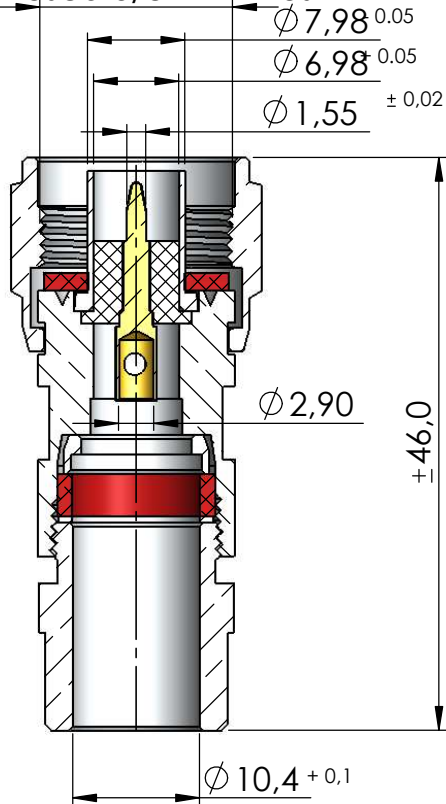

## Instruções montagem do cabo no conector

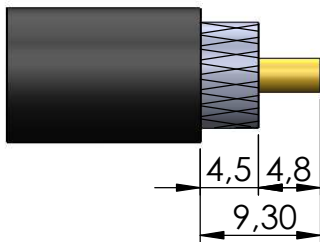

1) Corte do cabo.

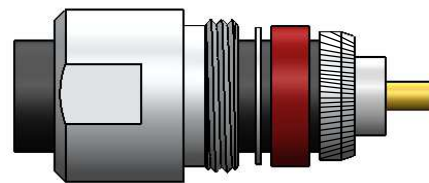

3) Dobrar a blindagem para traz e aparar - la.

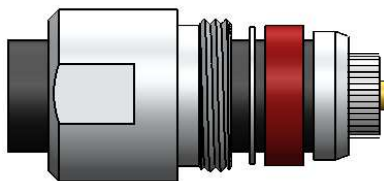

2) Introduzir redutor, arruela anel de vedação e a bucha cônica.

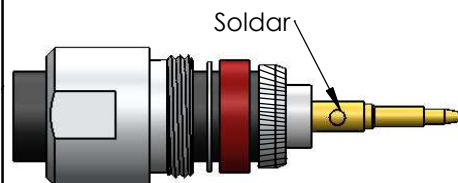

4) Introduzir o pino no condutor central, encostá -lo no dielétrico e soldar. Evitar excesso de calor para não deformar o dielétrico.

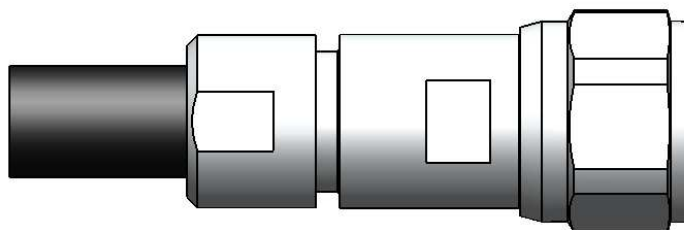

5) Introduzir o cabo no corpo do conector.