



# CONECTOR MACHO RETO PRENSA CABO RF-75 0,4/2,5

CÓDIGO: LM -106

SÉRIE: BNC 75 OHMS

NORMA: IEC 169-8

PESO DO CONECTOR: 14,08g

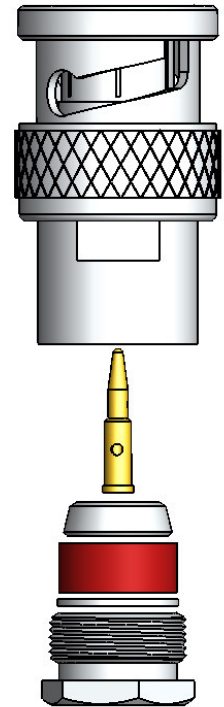
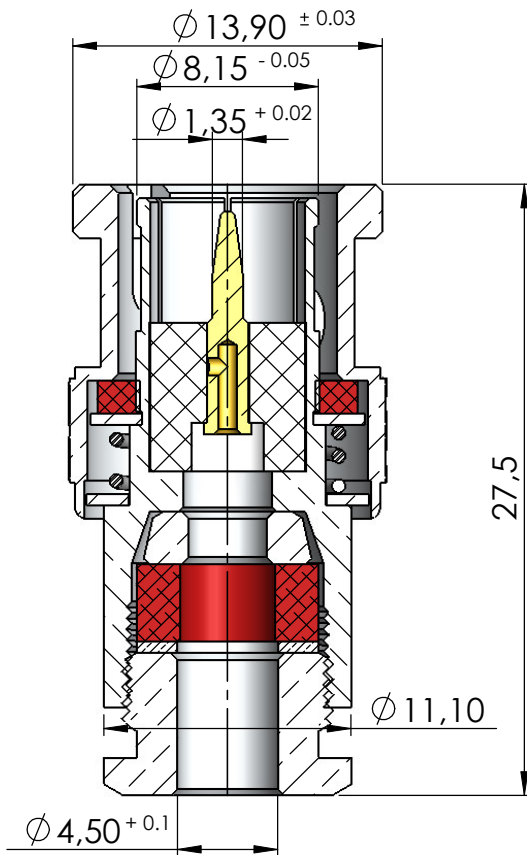

## Instruções montagem do cabo no conector

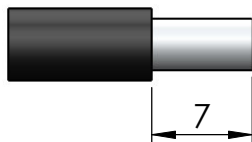

1) Corte do cabo.

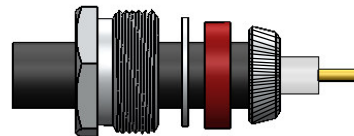

3) Dobrar a blindagem para traz e apará-la.

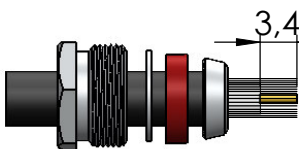

2) Desfiar a malha expondo 3,4mm do condutor central, fechar novamente a blindagem. Introduzir a porca, arruela, arruela neoprene e bucha cônica.

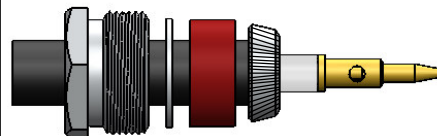

4) Introduzir o pino no condutor central, encostá-lo no dielétrico e soldar. Evitar excesso de calor para não deformar o dielétrico.

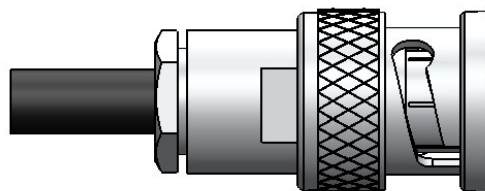

5) Introduzir o cabo no conector e apertar com chaves apropriadas.