



CONECTOR MACHO RETO COM BUCHA SHILDEN PRENSA CABO RG-58

CÓDIGO: LM-42

SÉRIE: BNC 50 OHMS

NORMA: IEC 169-8

PESO DO CONECTOR: 16,27g

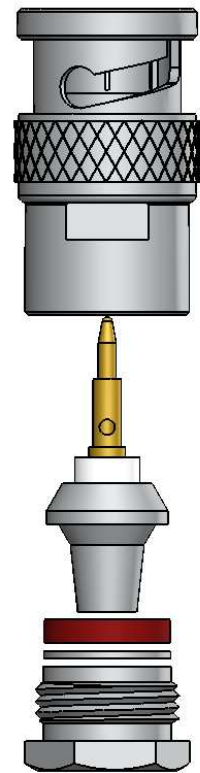
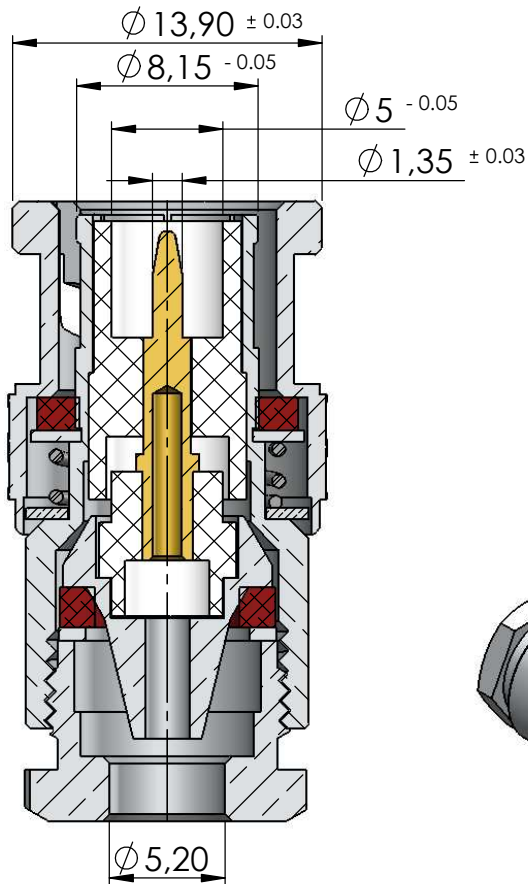

Instruções montagem do cabo no conector

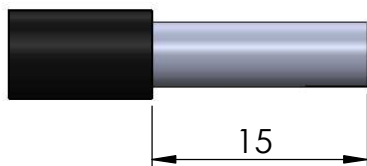

1) Corte do cabo.

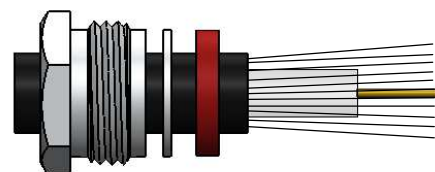

3) Introduzir o redutor, arruela e o anel de vedação.

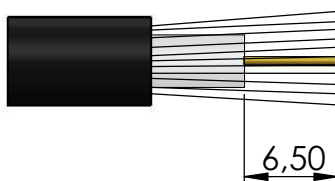

2) Abrir a malha expondo 6,5mm do condutor central, fechar novamente a blindagem.

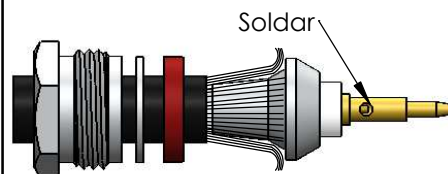

4) Soldar o condutor no pino fixado na bucha e fechar a malha. O dielétrico deverá encostar na parte isolada onde existe um rebaixo para tal finalidade.

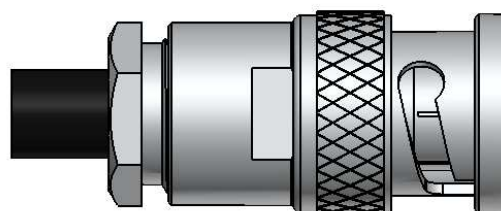

5) Introduzir o cabo com os componentes no conector e apertar com chaves apropriadas.