



CONECTOR MACHO RETO CRIMPAGEM CABO 0,31/1,40

CÓDIGO: 13030

SÉRIE: 1.0/2.3

NORMA: DIN 47297

PESO DO CONECTOR: 4,77g

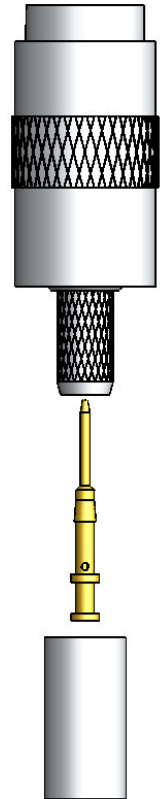
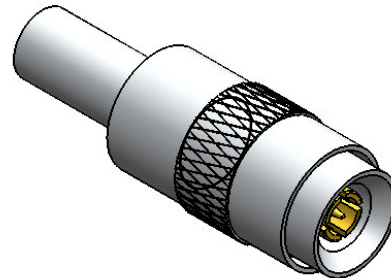
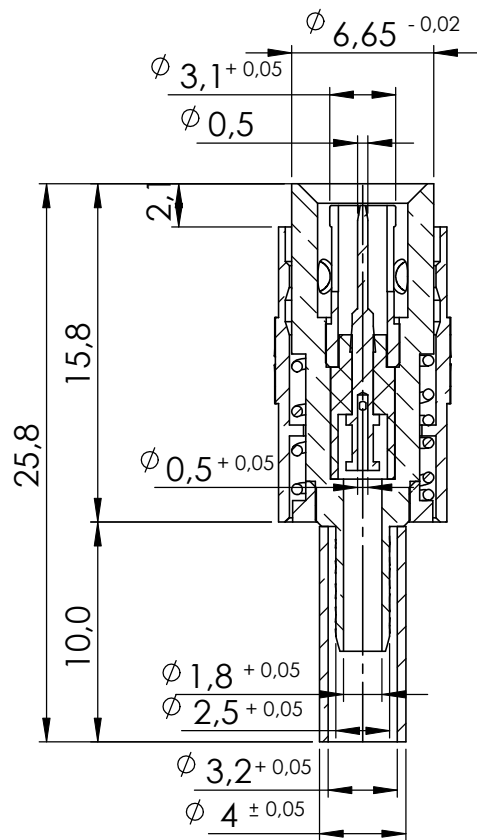

Instruções montagem do cabo no conector

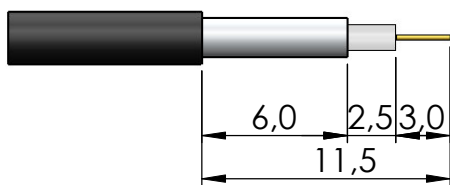

1) Corte do cabo.

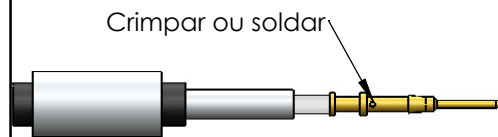

Crimpar ou soldar

3) Crimpar ou soldar o condutor central no pino.

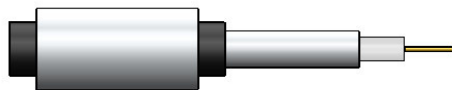

2) Introduzir a bucha no cabo.

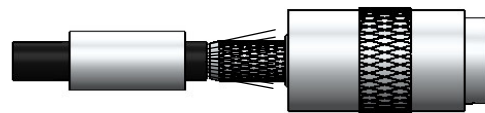

4) Introduzir o pino soldado no conector colocando a malha sobre a parte recartilhada do conector.

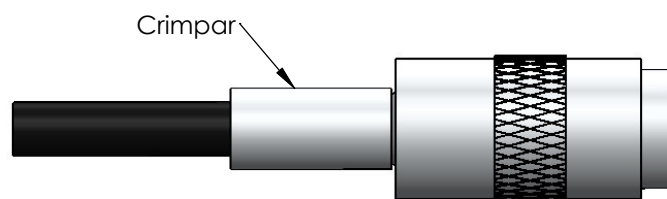

Crimpar

5) Colocar a bucha sobre a malha até encostar no conector e crimpá-la.