



CONECTOR FÊMEA RETO PRENSA CABO COAXIAL 1/2" RÍGIDO

CÓDIGO: 5014

SÉRIE: DIN 7/16

NORMA: IEC 169-4

PESO DO CONECTOR: 138,39g

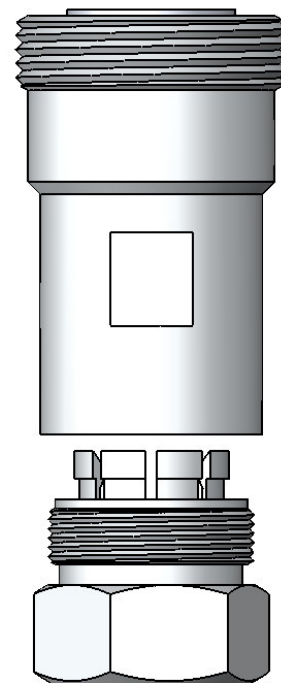
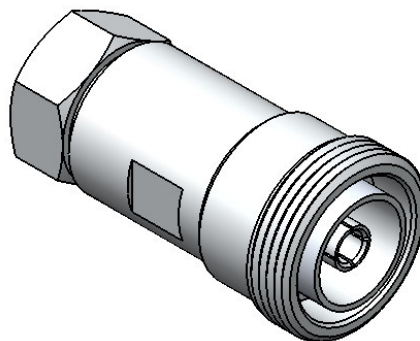
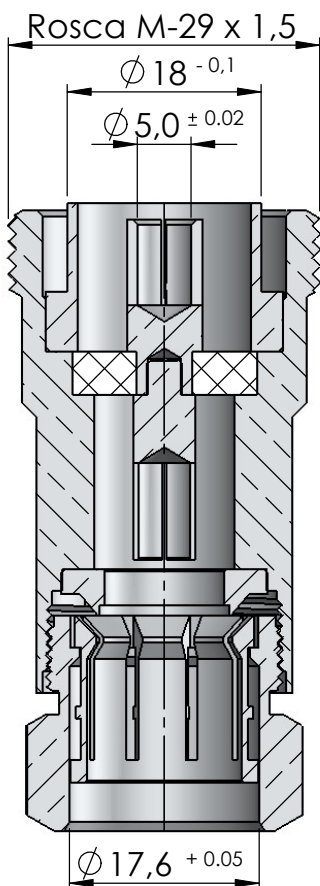

Instruções montagem do cabo no conector

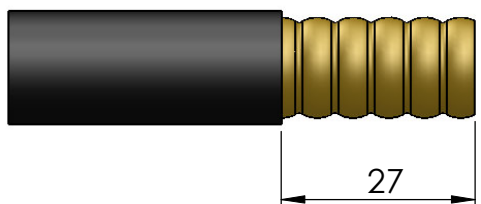

1) Cortar a capa de vinil.

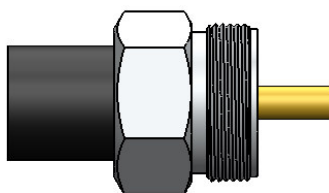

3) Cortar a fita de cobre com uma serra, paralelo ao redutor expondo 11mm do condutor central.

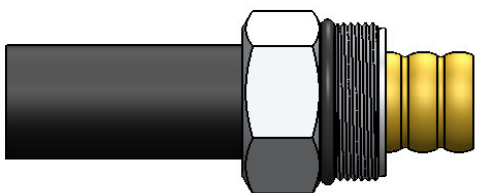

2) Introduzir o cabo no redutor e atracador.

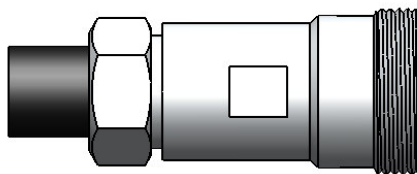

4) Introduzir o cabo com o redutor até encostar a fita de cobre na parte cônica do corpo. Rosquear o redutor no corpo com o auxílio de duas chaves.